

# EMC Components

# ZJSC Series

## 3-Terminal Filters for Signal Line and DC Power Line Lead

### FEATURES

- With a lead pitch of 2.5mm (identical to the terminal pitch of DIP type ICs), the ZJSC series T-type EMC filters enable the design of high-density circuit board configurations using automated insertion.
- Their sharp cutoff characteristics provide effective high-frequency attenuation with minimum effect on passband signals, even when such signals are at close proximity to the trapband.
- The series are available in an extensive range of cutoff frequencies, enabling their use in a wide range of applications.
- The use of highly miniaturized inductor elements helps minimize variations in the mounted heights of circuit board components. This plus the use of round leads ensures superior clinchability and insertability, making this product ideal for use in automated mounting production lines.

### PRODUCT IDENTIFICATION

ZJSC - 2R2 - 101 - TA  
(1) (2) (3) (4)

- (1) Series name  
(2) Inductance value 2R2:2.2μH×2  
(3) Capacitance 101:100pF  
(4) Packaging style TA: Taping\*

\* Only used for bulk packaged products. This should become "TAH" when using TDK's AVI-SERT automatic assembly equipment feeder.

### SHAPES AND DIMENSIONS

#### TAPING SPECIFICATIONS

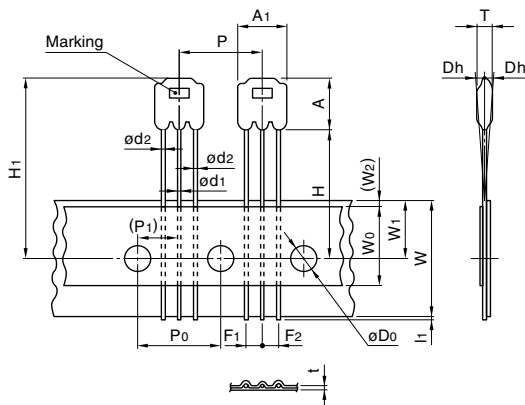

#### BULK SPECIFICATIONS TYPICAL MOUNTING EXAMPLE



### APPLICATIONS

Home electronic equipment, (TVs, VCRs, CD players, DAT players, electric musical instruments, PCs, etc.), office automation equipment (computers, terminals, stand-alone word processors, fax machines, etc.), factory automation equipment

### BASIC CHARACTERISTICS

Rated voltage E <sub>dc</sub>	50V max.
Withstand voltage E <sub>dc</sub> [Between terminal No.1, 3 to 2]	125V
Insulation resistance [DC. 50V for 1min]	10000MΩ min.
Operating temperature range	-25 to +85°C

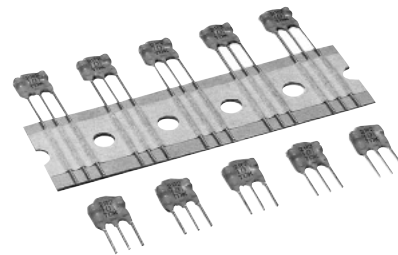

Dimensions in mm

Component width	A <sub>1</sub>	7.5max.
Component height	A	8max.
Component thickness	T	2.4max.
Lead wire diameter (round)	ød <sub>1</sub> ød <sub>2</sub>	0.5±0.05 0.6±0.05
Component pitch	P	12.7±1
Feed hole pitch* <sup>1</sup>	P <sub>0</sub>	12.7±0.3
Feed hole position error	P <sub>1</sub>	6.35±0.4
Lead pitch* <sup>2</sup>	F <sub>1</sub> , F <sub>2</sub>	2.5±0.4, -0.1
Component alignment	Δh	0±2
Tape width	W	18±1, -0.5
Cover tape width	W <sub>0</sub>	12±0.3
Feed hole position error	W <sub>1</sub>	9±0.5
Cover tape position	(W <sub>2</sub> )	(4max.)
Component bottom position* <sup>3</sup>	H	16±1
Maximum component height* <sup>4</sup>	H <sub>1</sub>	24.5max.
Feed hole diameter	øD <sub>0</sub>	4±0.2
Total tape thickness	t	0.5±0.2
Lead wire protrusion	l <sub>1</sub>	0.5max.
Lead wire length	l	5±1.5
Lead pitch* <sup>5</sup>	f <sub>1</sub> , f <sub>2</sub>	2.5±0.5

\*<sup>1</sup> The permissible cumulative pitch error is within ±1mm of 20 pitches.

\*<sup>2</sup> The dimension at the end of the lead pitch is also within the tolerance.

\*<sup>3</sup>, \*<sup>4</sup> When TAH has been set in the taping specification \*<sup>3</sup> and \*<sup>4</sup>, it becomes 20±1mm and 28mm max. respectively.

\*<sup>5</sup> The tolerance of lead pitch is the dimensions when a lead is released from the tape. Not available for bulk packaging.

# EMC Components

## ZJSC Series

### 3-Terminal Filters for Signal Line and DC Power Line Lead

#### ELECTRICAL CHARACTERISTICS

Part No.	Cutoff frequency [Theoretical value] (MHz)ref.	Frequency range(MHz)		Rated voltage Edc(V)max.	Rated current (mA)max.	Characteristic impedance Zo (Ω)ref.
		25dB min.	40dB min.			
ZJSC-R10-120	210	600 to 1000	900 to 1000	50	450	75
ZJSC-R10-470	100	300 to 1000	500 to 1000	50	500	65
ZJSC-R15-180	150	400 to 1000	700 to 1000	50	450	75
ZJSC-R15-121	50	150 to 1000	300 to 1000	50	500	50
ZJSC-R47-121	30	100 to 1000	200 to 500	50	500	90
ZJSC-R47-181	25	100 to 1000	150 to 500	50	500	70
ZJSC-R47-391	17	70 to 1000	150 to 500	50	500	50
ZJSC-1R0-103	2.3	15 to 1000	40 to 500	50	400	15
ZJSC-2R2-101	15	40 to 1000	70 to 400	50	300	210
ZJSC-220-101	5	10 to 500	15 to 300	50	100	660
ZJSC-470-331	1.8	4 to 500	7 to 300	50	60	530

- The insertion loss response is measured across a 50Ω test impedance.

#### TYPICAL ELECTRICAL CHARACTERISTICS

##### ATTENUATION vs. FREQUENCY CHARACTERISTICS

Glass epoxy coated double side mounting PCB(t=1.6mm)

Test impedance: 50Ω

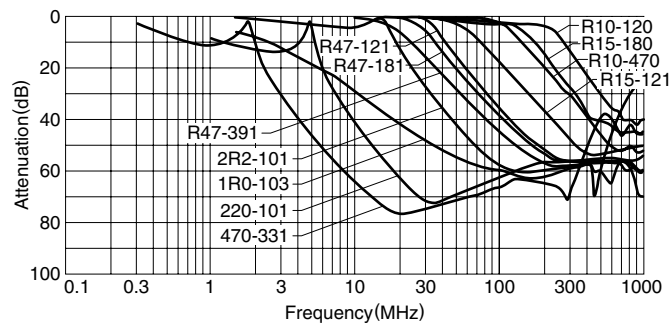

Characteristic impedance: 50 to 660Ω

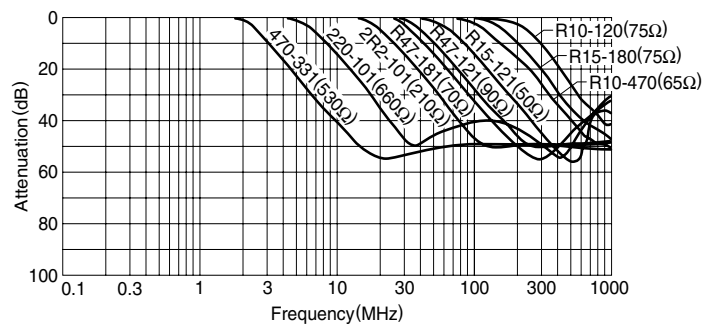

#### CIRCUIT DIAGRAM

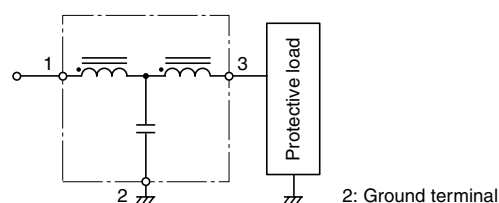

2: Ground terminal

#### PACKAGING STYLE AND QUANTITIES

Packaging style	Quantity
Taping	2000 pieces/reel

#### PACKAGING STYLE (Ammo-pack)

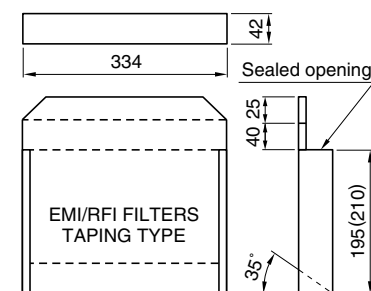

Dimensions in mm

#### INDICATES INTERIOR CONTENTS OF BOX

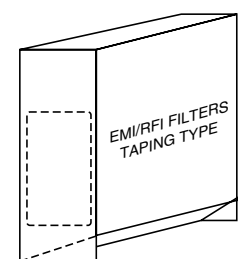

- When using a TDK AVI-SERT automatic assembly equipment feeder, use dimension ( ) to designate the "TAH" taping specification.

# EMC Components

## ZJSC Series

### 3-Terminal Filters for Signal Line and DC Power Line Lead

#### TECHNICAL NOTES

##### INSERTION ATTENUATION MEASUREMENT METHOD

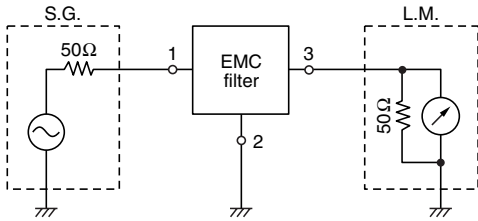

$$\text{Attenuation} = \log_{10} \frac{E_2}{E_1} \text{ (dB)}$$

E2: Set EMC filter in the circuit  
E1: Leave EMC filter in the circuit

##### MOUNTING SUBSTRATE FOR MEASUREMENT

Mount on the glass fabric-backed epoxy resin double-sided through-hole substrate (t=1.6mm)

##### MEASUREMENT TEMPERATURE

+5 to +35°C

##### TYPICAL APPLICATIONS

An example of radiated noise suppressing circuit by connecting a PC and a printer.

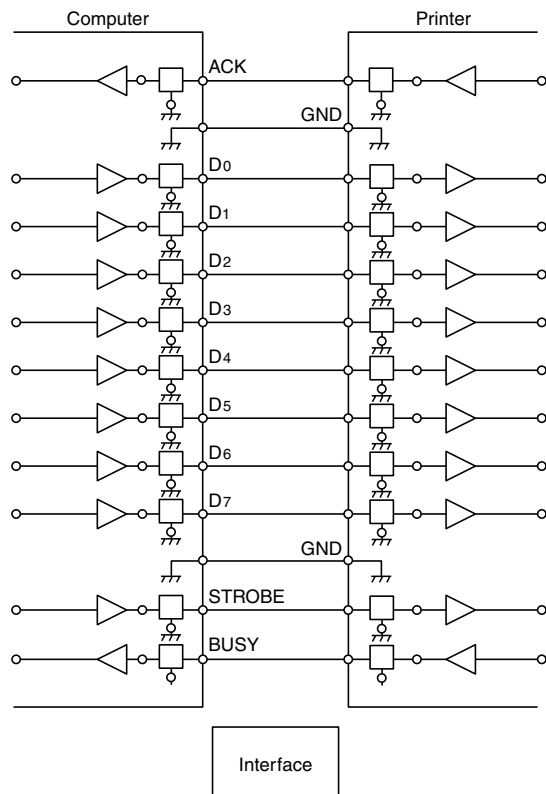

#### EXAMPLES OF MEASURING NOISE SUPPRESSION EFFECT (Waveform spectrum)

##### (1) MEASUREMENT CIRCUIT

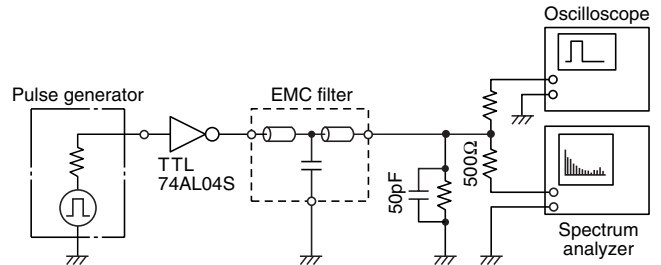

##### PULSE WAVEFORM

###### WITHOUT EMC FILTER

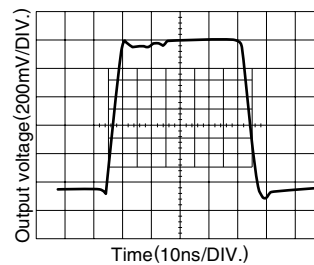

###### WITH EMC FILTER

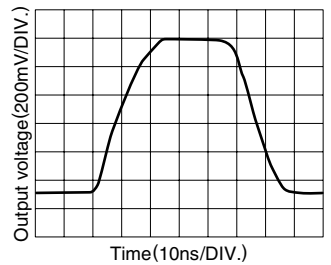

##### (2) MEASUREMENT RESULTS

###### (a) SPECTRUM WITHOUT EMC FILTER

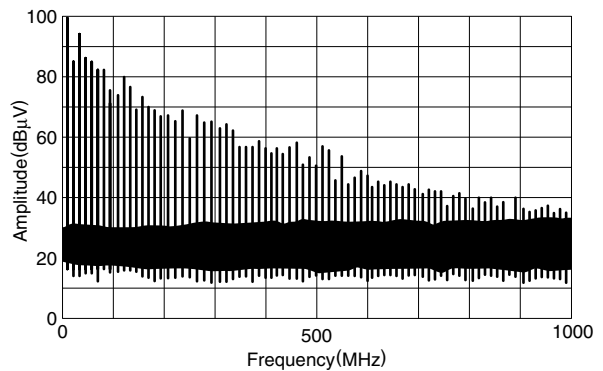

###### (b) SPECTRUM WITH EMC FILTER

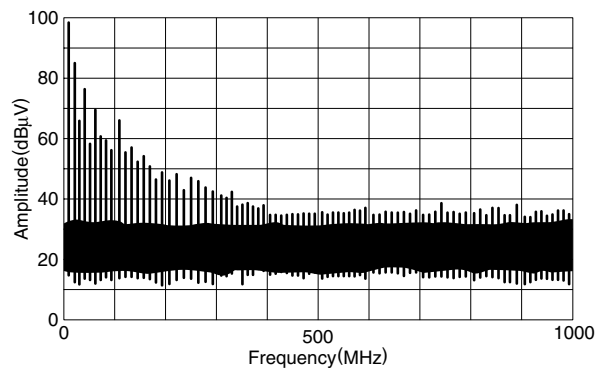

# EMC Components

# ZJSC Series

## 3-Terminal Filters for Signal Line and DC Power Line Lead

### AN EXAMPLE OF MEASURING NOISE SUPPRESSION EFFECT (Radiation spectrum)

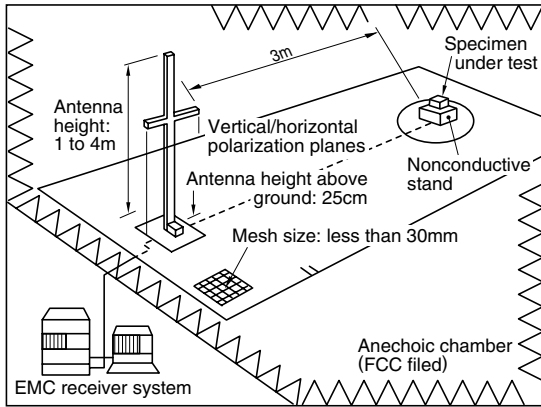

### RADIATION LEVEL (a) WITHOUT EMC FILTER

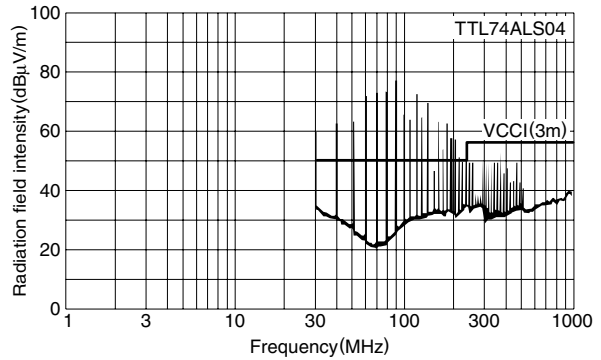

### (b) WITH EMC FILTER

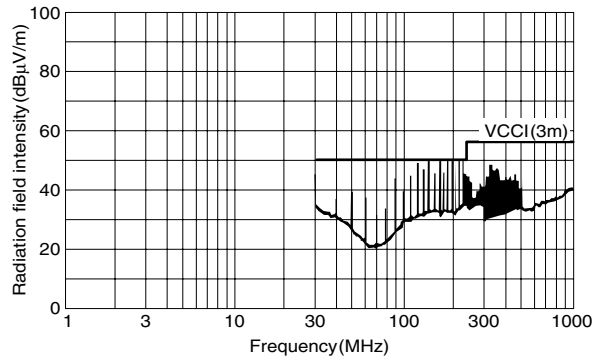

### TTL OUTPUT WAVEFORM WITHIN A SHIELDING CASE

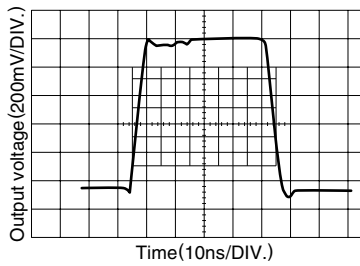

### MODEL

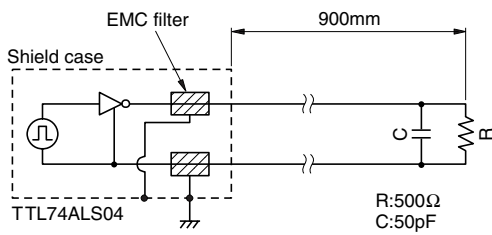

### BICONICAL ANTENNA INDUCED WAVEFORM

